





## 1996

### KICK OFF

We started producing rubber compounds for wires and cables.

## 1997

### A RADICAL CHANGE

Pioneer in producing rubber pellets, now globally used, instead of strips.

## 2001

### NEW PLANT

Based on a unique manufacturing process and completely in-house designed.

## 2008

### 2.0 SECOND RELEASE

We integrated new machinery to reach 25,000 MTons/year of production capacity.

## OUR MISSION



We provide quality solutions for cable manufacturers to grow their productivity of top notch, cost-effective and safe power cables, according to the highest professional standards.

## OUR VISION



Transferring our passion for innovation and improvement to the whole cable value chain.

## OUR VALUES



### CONSISTENCY

We put in a strong effort to fulfill our customers' high expectations.

### COOPERATION

We believe that working together is the key of a trustworthy relationship.

### COMMITMENT

Our customer's success is our success.



**MIXER  
COMPOUNDS**  
DETAILS MATTER.

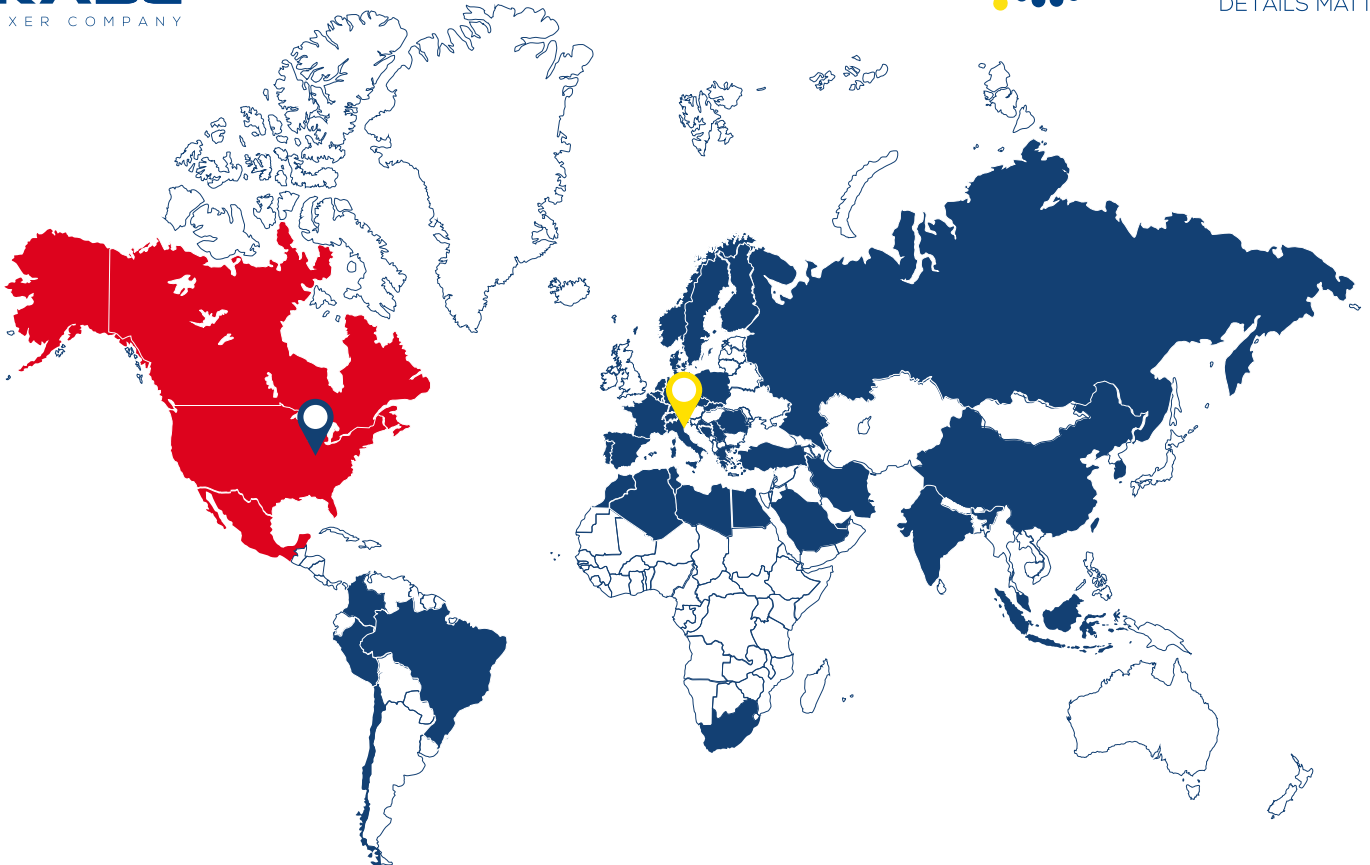

2016

**A GLOBAL APPROACH**

We currently export to more than 30 countries worldwide.

2020

**XO TRADE**

Foundation of the Mixer's business unit based in Columbus, Ohio, USA

2021

**25<sup>th</sup> ANNIVERSARY**

We celebrate our company, together with the people who made it possible. Every day.

2022

**EKOGRAFT®**

Silane curable products.

**CROSSLINKABLE RUBBER COMPOUNDS**

CV or EB curable

**THERMOPLASTIC COMPOUNDS**

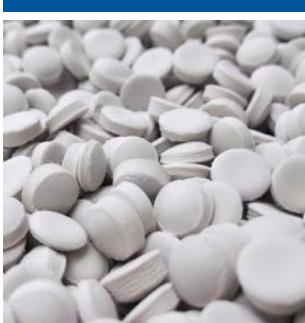

**LOW VOLTAGE INSULATION COMPOUNDS**

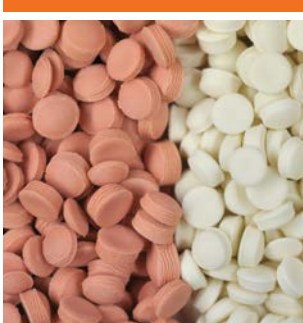

**MEDIUM VOLTAGE INSULATION COMPOUNDS**

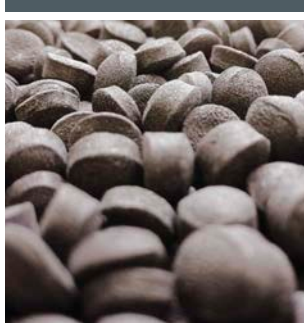

**SHEATHING COMPOUNDS**

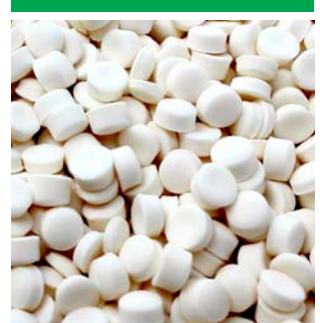

**BEDDING COMPOUNDS**

**ECO-FRIENDLY TECHNOLOGIES**



Halogen Free



Lead Free



Low PAH



Phthalate Free



RoHS

**OTHER TECHNOLOGIES**



Dicumyl Peroxide



Drumable



Easy Peeling



Fire Resistant



Flexible



For CPR



Gas Fading Resistant



Heavy Duty Applications



High Speed Extrusion



Low Compr. Set



Low Smoke Emission



Migration Resistant



Oil Resistant



Ozone Resistant



Thermal Endurance 20,000 h



Water Resistant



**MIXER  
COMPOUNDS**

DETAILS MATTER.

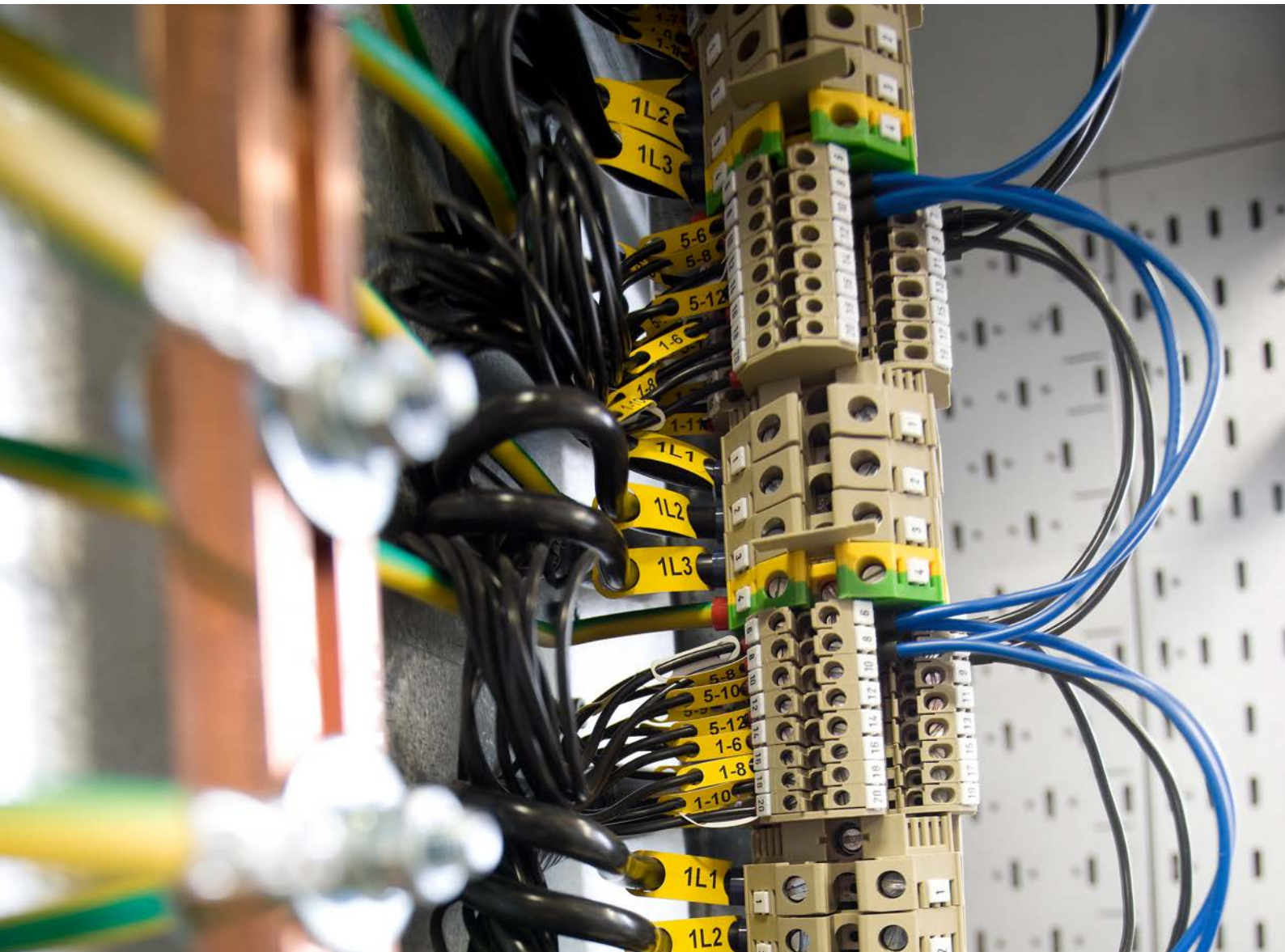

















































# LOW VOLTAGE RUBBER INSULATION COMPOUNDS

















































































**EKOPREN®**

[mixercompounds.com](http://mixercompounds.com)

# EPDM

	APPLICATION	TS MPa	EB %	DENSITY g/cm <sup>3</sup>	HARDNESS SHORE	LOI %	PROPERTIES
EKOPREN® 3IS051	EI4	5	200	1,52	77 (A)	-	       
EKOPREN® 3IS061	EI4-EI7	6	200	1,49	77 (A)	-	       
EKOPREN® 3IS071	EI4-EI6-EI7-GP4	6,5	200	1,47	75 (A)	-	       
EKOPREN® 3IS671	EI4-EI7 FR	6	200	1,46	80 (A)	24	       
EKOPREN® 3IS111	HEPR-G7	9	200	1,32	80 (A)	-	       
EKOPREN® 3IS661	G7 FR	9	200	1,40	83 (A)	23	       

# HFFR

	APPLICATION	TS MPa	EB %	DENSITY g/cm <sup>3</sup>	HARDNESS SHORE	LOI %	PROPERTIES
EKOPREN® 3IS781	EI8	9	250	1,45	85 (A)	27	       
EKOPREN® 3IS971	EI8-EI3	9	250	1,49	86 (A)	29	       
EKOPREN® 3IS921	EI8-EI5-G9	13	160	1,53	47 (D)	30	       
EKOPREN® 3IS92E	EI8-EI5-G9	13	160	1,53	46 (D)	30	       
EKOPREN® 3IS901	EI8-EI5-EI3-PV*	10	200	1,44	85 (A)	26	       
EKOPREN® 3IS981	PV*	10	200	1,41	46 (D)	26	       
EKOPREN® 3IS771	EI5-EI101-EI102 EI103-EI04	10	160	1,56	44 (D)	30	       
EKOPREN® 3IS801	EI5-EI106-EI107 EI108-EI109-EI110	10	160	1,57	42 (D)	30	       
EKOPREN® 3IS821	G18	10	150	1,45	90 (A)	27	       
EKOPREN® 3IS951	T3 ISO 6722 THIN WALL - SAE J1128	12,5	200	1,44	48 (D)	27	       

\*EN 50618



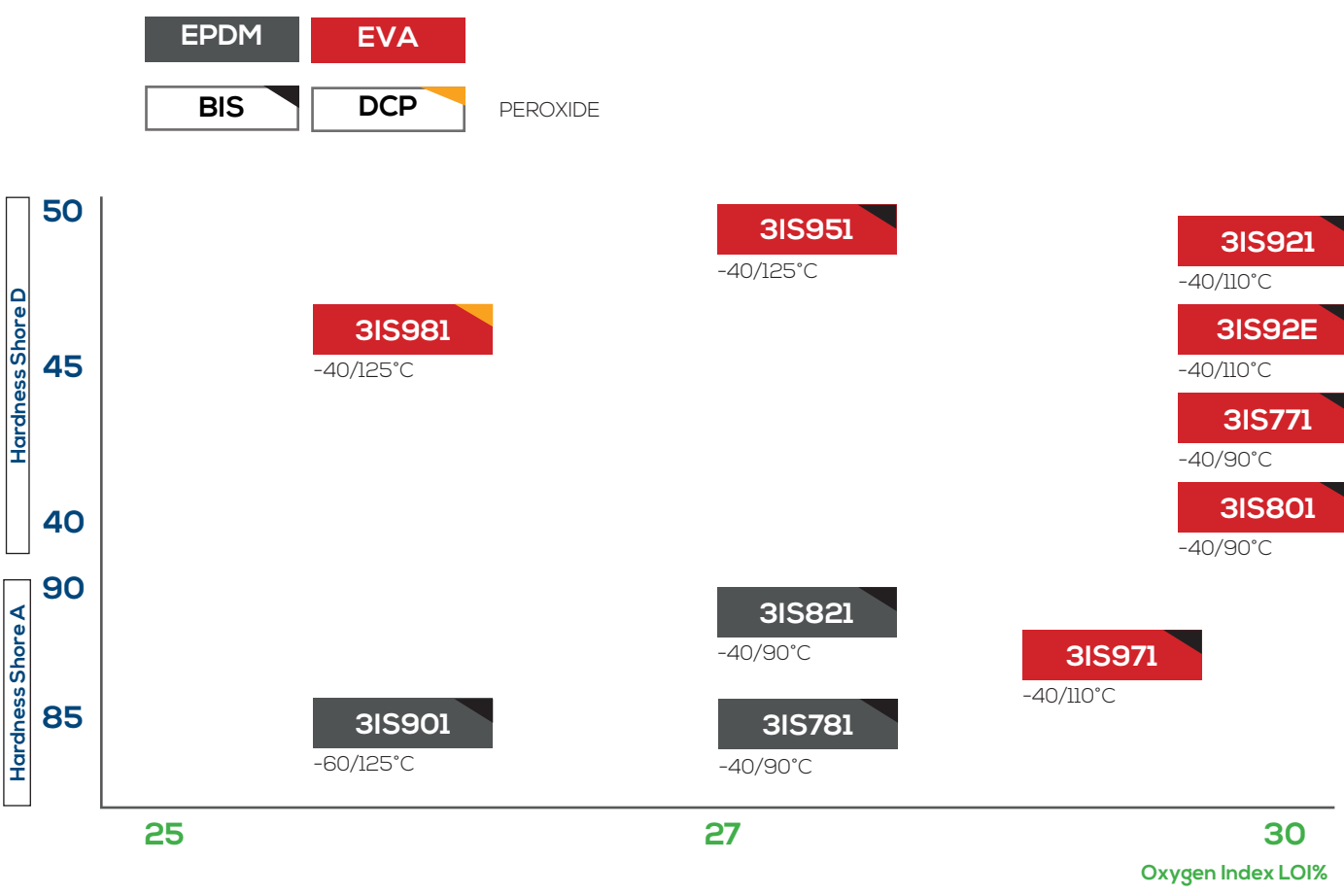
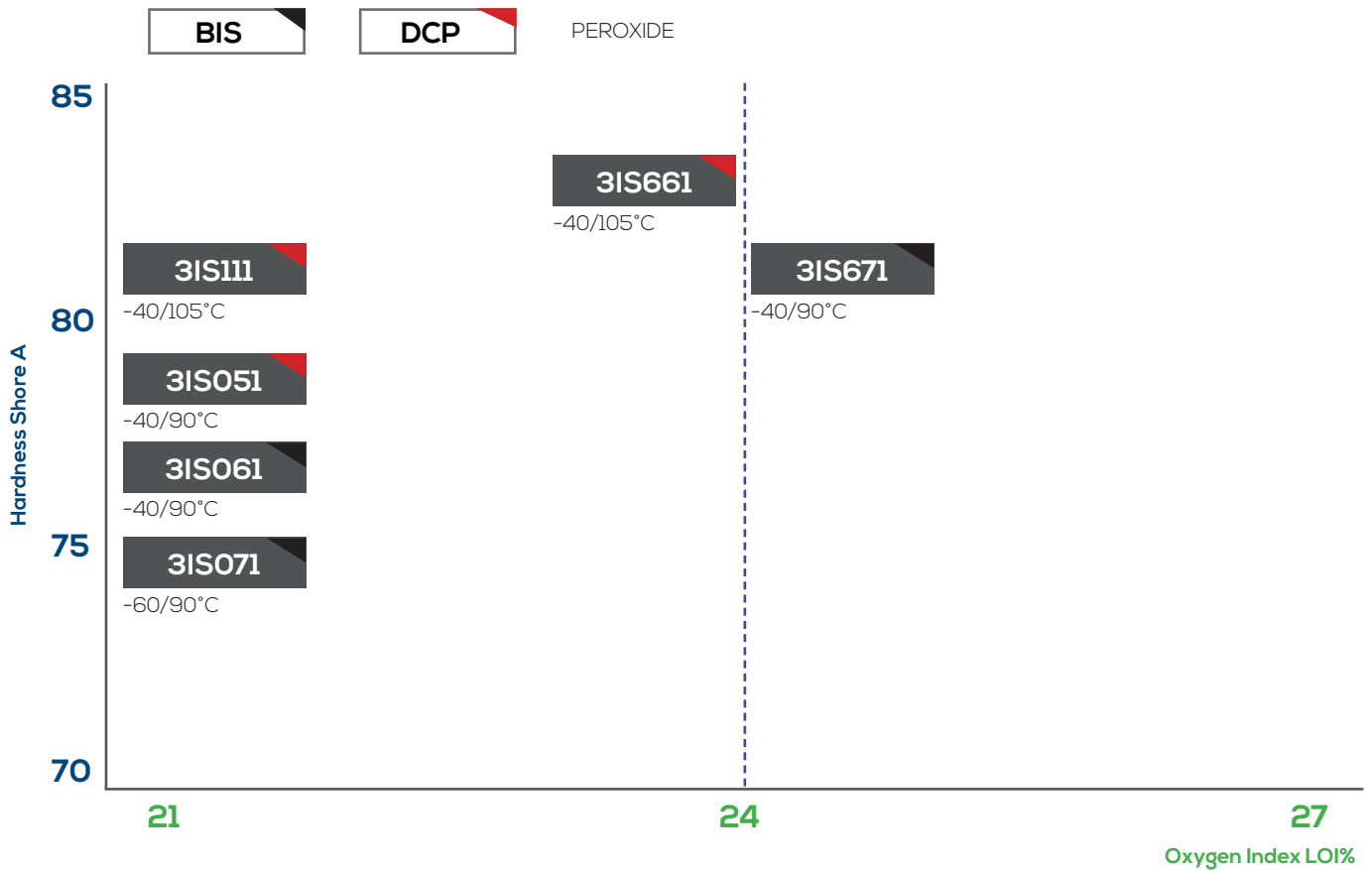



**MIXER  
COMPOUNDS**

DETAILS MATTER.



**MEDIUM VOLTAGE  
RUBBER INSULATION COMPOUNDS 6-95 kV**

**EKOPREN®**

[mixercompounds.com](http://mixercompounds.com)



WITH LEAD  
LEAD FREE



## UP TO 20 kV

		APPLICATION	TS MPa	EB %	DENSITY g/cm <sup>3</sup>	HARDNESS SHORE	PROPERTIES
EKOPREN® 3IS73L	● ○	HEPR	11	300	1,24	83 (A)	
EKOPREN® 3IS75L	● ○	HEPR	11	300	1,22	85 (A)	

## UP TO 35 kV

		APPLICATION	TS MPa	EB min %	DENSITY g/cm <sup>3</sup>	HARDNESS SHORE	PROPERTIES
EKOPREN® 3IS011		EPR	9	200	1,20	68 (A)	
EKOPREN® 3IS01S		EPR/FAST CURING	9	200	1,22	67 (A)	
EKOPREN® 3IS031		EPR	9	200	1,16	70 (A)	
EKOPREN® 3IS73F	○	HEPR	11	300	1,20	82 (A)	
EKOPREN® 3IS75F	○	HEPR	11	300	1,18	82 (A)	

## UP TO 69 kV

		APPLICATION	TS MPa	EB %	DENSITY g/cm <sup>3</sup>	HARDNESS SHORE	PROPERTIES
EKOPREN® 3IS691		HEPR	11	300	1,21	85 (A)	
EKOPREN® 3IS74F	○	HEPR	11	300	1,18	82 (A)	
EKOPREN® 3IS79F	○	HEPR	11	300	1,19	85 (A)	

## UP TO 95 kV

		APPLICATION	TS MPa	EB %	DENSITY g/cm <sup>3</sup>	HARDNESS SHORE	PROPERTIES
EKOPREN® 3IS721		HEPR	11	200	1,17	80 (A)	

- COST EFFECTIVE SOLUTION
- SUITABLE ALSO FOR XLPE SCREW







WITH LEAD

LEAD FREE

MULTICORE

SINGLE CORE

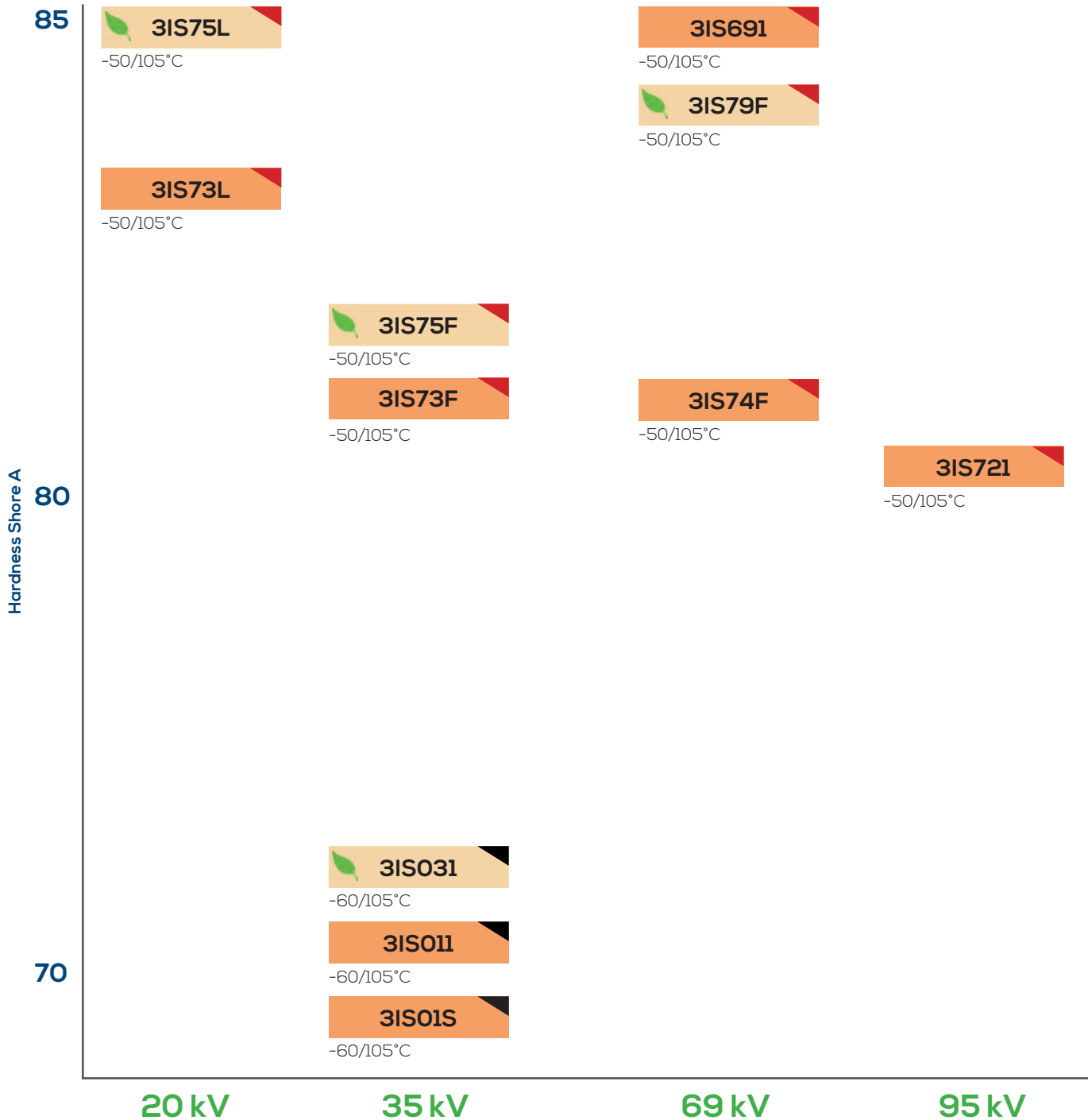

See the attached "MV suggested semiconductive" flyer

# EKOPREN®



## MEDIUM VOLTAGE

Suggested Semiconductive Compounds

### HIGH % EPDM

3IS011 - 3IS031 - 3IS691 - 3IS711 - 3IS721

#### BOREALIS

**BONDED**

LE 0592

**STRIPPABLE**

LE 0516  
LE 0315

#### PRAMKOR

**BONDED**

1001

**STRIPPABLE**

3007  
3009

#### TRELLEBORG

**BONDED**

E 6595

**STRIPPABLE**

E 8458  
E 8406

### LOW % EPDM

3IS731 - 3IS741 - 3IS751 - 3IS791

#### HANWHA

**BONDED**

8730

**STRIPPABLE**

8735

#### PRAMKOR

**BONDED**

1001

**STRIPPABLE**

3005

#### TRELLEBORG

**BONDED**

E 6595

**STRIPPABLE**

E 8462  
E 8406



**MIXER  
COMPOUNDS**

DETAILS MATTER.

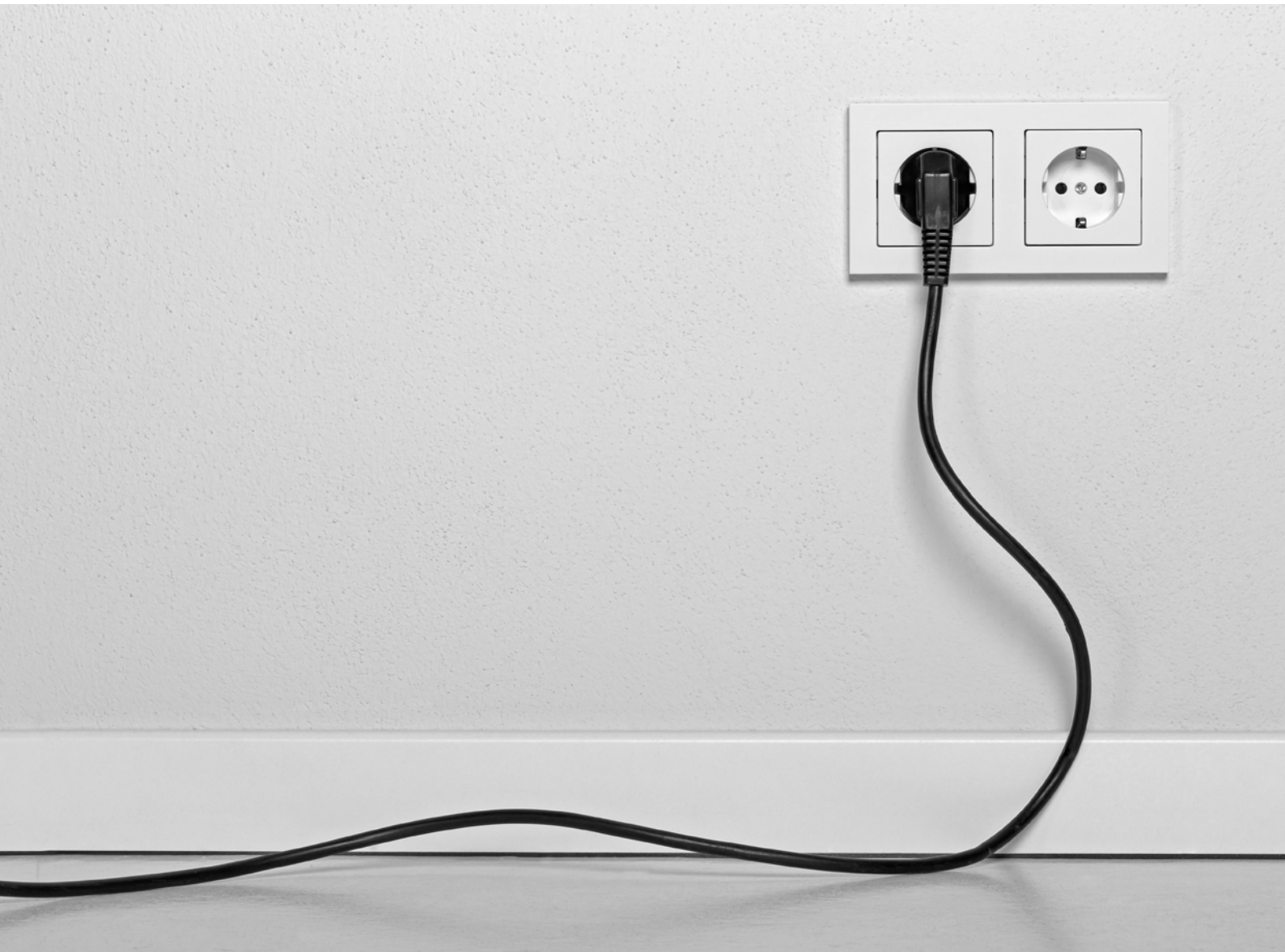







# FLEXIBLE SHEATHING RUBBER COMPOUNDS









**EKOPREN®**

[mixercompounds.com](http://mixercompounds.com)















## NBR/PVC

	APPLICATION	TS MPa	EB %	DENSITY g/cm <sup>3</sup>	HARDNESS SHORE	LOI %	PROPERTIES
EKOPREN® 3SH351	EM2	11	350	1,46	72 (A)	28	  
EKOPREN® 3SH411	EM2	11	350	1,44	67 (A)	26	  













## CPE

	APPLICATION	TS MPa	EB %	DENSITY g/cm <sup>3</sup>	HARDNESS SHORE	LOI %	PROPERTIES
EKOPREN® 3SH93A	EM2-EM5-EM7	11	400	1,44	76 (A)	27	  
EKOPREN® 3SH941	EM2-EM5-EM7	11	400	1,45	75 (A)	24	 
EKOPREN® 3SH951	EM2-EM5-EM7	11	400	1,44	73 (A)	25	   

## CPE+

	APPLICATION	TS MPa	EB %	DENSITY g/cm <sup>3</sup>	HARDNESS SHORE	LOI %	PROPERTIES
EKOPREN® 3SH471 ●	EM2-5GM3-EM7	11	320	1,44	75 (A)	28	    
EKOPREN® 3SH481	XL CPE NEMA WC70	12,5	320	1,39	66 (A)	30	   
EKOPREN® 3SH511	UL1581 50,28 TO 50,31, 50,33 EM7-5GM3	15	400	1,39	76 (A)	29	    

## HFFR

	APPLICATION	TS MPa	EB %	DENSITY g/cm <sup>3</sup>	HARDNESS SHORE	LOI %	PROPERTIES
EKOPREN® 3SH611	EM3-EM6	7	250	1,38	76 (A)	-	 
EKOPREN® 3SH661	EM2-EM3-EM5 EM6-EM7	10	300	1,30	77 (A)	23	    
EKOPREN® 3SH821 ●	SHF2-PV*-M2 EM8-EM101-EM102 EM103-EM104	10	150	1,58	44 (D)	31	     

● COLORABLE

\* EN 50618





NBR/PVC

CPE

CPE+

HFFR

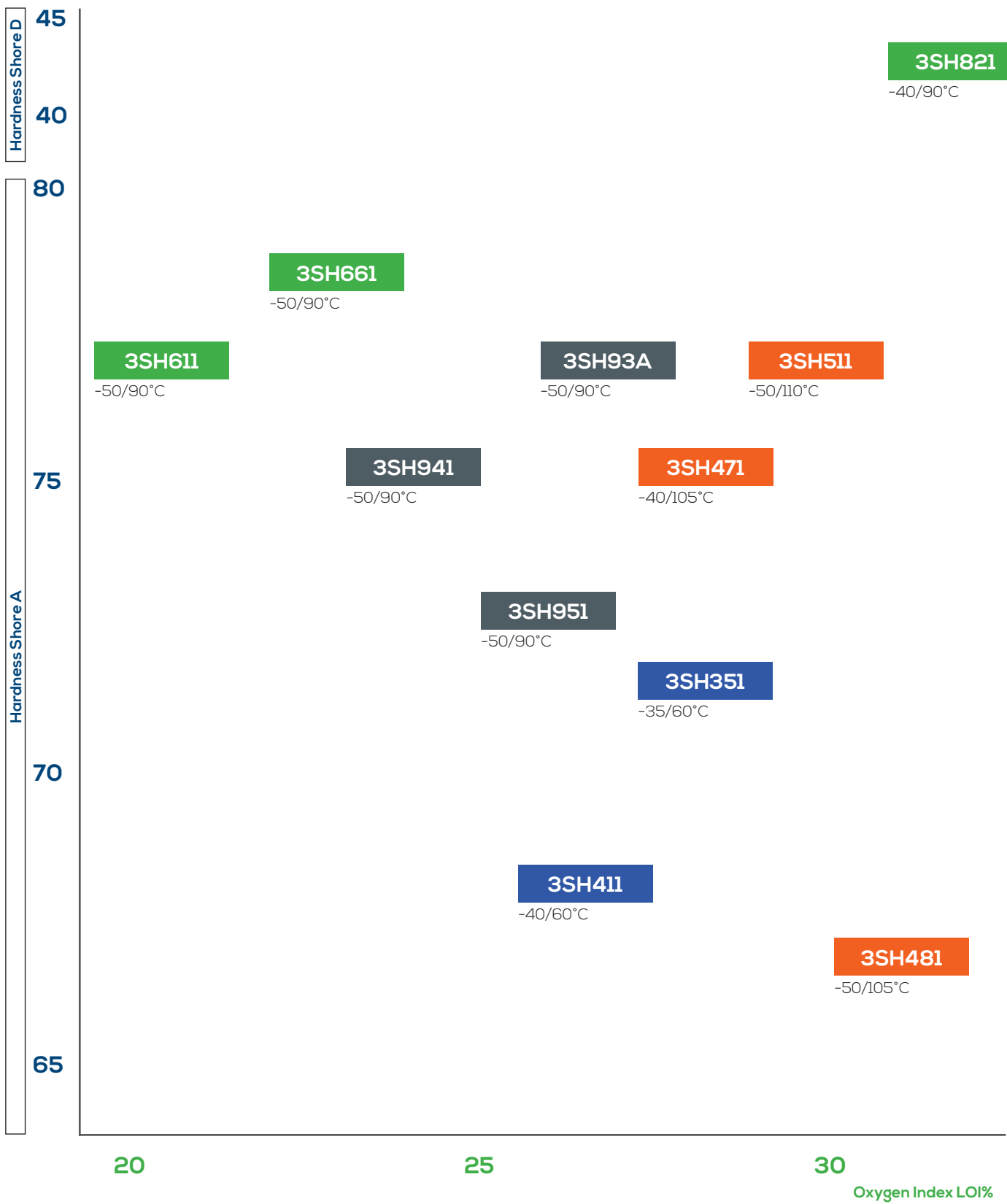



**BEDDING  
THERMOPLASTIC COMPOUNDS**

**EKOPREN®**



## PVC/PVC Tandem

ROHS  
✓ ALL

	DENSITY g/cm <sup>3</sup>	HARDNESS SHORE	LOI %	PROPERTIES
EKOPREN® 3RP081	1,93	73 (A)	-	
EKOPREN® 3RP08E	1,87	80 (A)	-	

## XLPE/PVC Tandem

	DENSITY g/cm <sup>3</sup>	HARDNESS SHORE	LOI %	PROPERTIES
EKOPREN® 3RP501	1,91	72 (A)	26	
EKOPREN® 3RP521	1,87	70 (A)	35	
EKOPREN® 3RP52M	1,87	70 (A)	35	
EKOPREN® 3RP531	1,86	70 (A)	45	
EKOPREN® 3RP571	1,83	76 (A)	60	
EKOPREN® 3RP601	1,93	78 (A)	-	

## XLPE/HFFR Tandem

	DENSITY g/cm <sup>3</sup>	HARDNESS SHORE	LOI %	PROPERTIES
EKOPREN® 3RP52H	1,82	76 (A)	35	
EKOPREN® 3RP53H	1,83	75 (A)	45	
EKOPREN® 3RP57H	1,80	72 (A)	60	
EKOPREN® 3RP921	1,85	40 (D)	35	
EKOPREN® 3RP931	1,84	37 (D)	45	
EKOPREN® 3RP93A	1,84	43 (D)	45	
EKOPREN® 3RP961	1,80	90 (A)	52	
EKOPREN® 3RP96A	1,79	43 (D)	52	

## XLPE/HFFR Drummable

	DENSITY g/cm <sup>3</sup>	HARDNESS SHORE	LOI %	PROPERTIES
EKOPREN® 3RP301	1,88	80 (A)	-	
EKOPREN® 3RP311	1,82	74 (A)	30	
EKOPREN® 3RP321	1,80	76 (A)	35	
EKOPREN® 3RP361	1,75	82 (A)	52	
EKOPREN® 3RP371	1,74	86 (A)	65	
EKOPREN® 3RP421	1,66	73 (A)	35	
EKOPREN® 3RP431	1,70	75 (A)	45	



TANDEM

DRUM

TEMPERATURE RATING: 90°C (ALL)

CPR

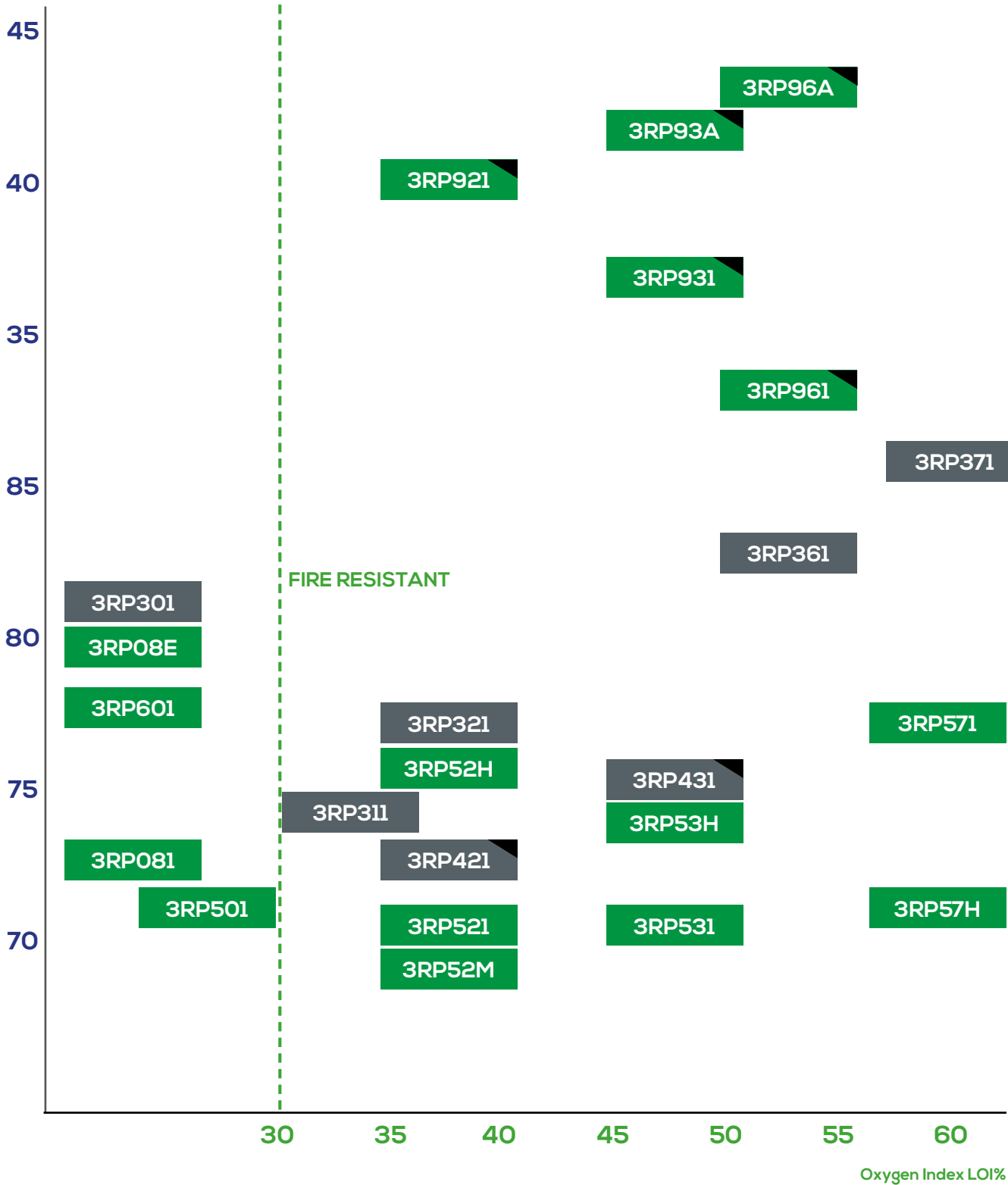

Halogen Free



Phthalate Free



Drumable



Easy Peeling



Fire Resistant



Flexible



For CPR



High Speed Extrusion



Low Smoke Emission



Migration Resistant







**MIXER  
COMPOUNDS**

DETAILS MATTER.



**PACKAGING SOLUTIONS**

**EKOPREN®**

[mixercompounds.com](http://mixercompounds.com)

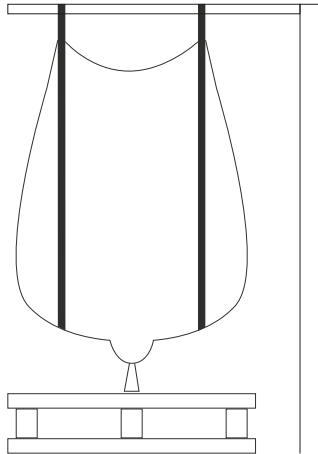

### **BIG BAG (CODE: 04)**

MADE OF:

- PP big bag
- Corrugated cardboard
- Pallet

ALTERNATIVE USE

PP big bag: garbage bag  
wood: reusable

QUANTITY RANGE: 850-1200 kg

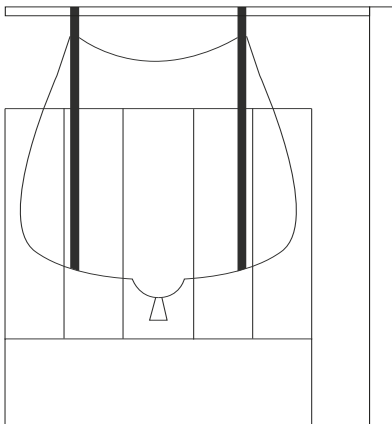

### **STACKABLE METAL CRATE + BIG BAG (CODE: 05)**

MADE OF:

- PP big bag
- Metal

ALTERNATIVE USE

PP big bag: garbage bag  
metal crate: reusable and returnable

QUANTITY RANGE: 900-1000 kg

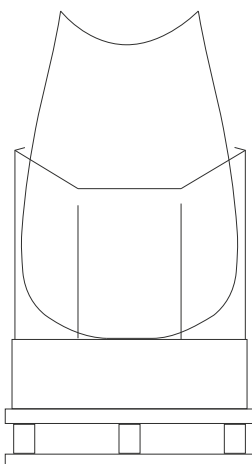

### **OCTABIN (CODE: 08)**

MADE OF:

- PE liner
- PP straps
- Corrugated cardboard
- Pallet CP9

ALTERNATIVE USE

PE line: garbage bag  
corrugated cardboard: garbage bag  
wood: reusable

QUANTITY RANGE: 600-1000 kg

#### **RECYCLING**

dispose of in accordance with local requirements

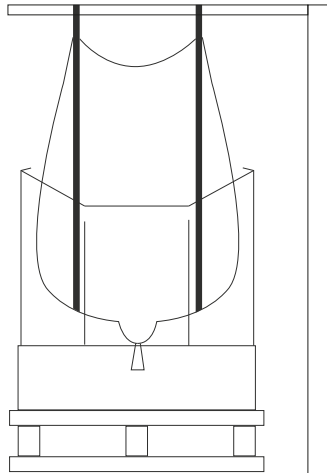

### BB OCTABIN (CODE: 20)

MADE OF:

- PP big bag
- PP straps
- Corrugated cardboard
- Pallet CP9

ALTERNATIVE USE

- PP big bag: garbage bag
- corrugated cardboard: garbage bag
- wood: reusable

QUANTITY RANGE: 600-1000 kg

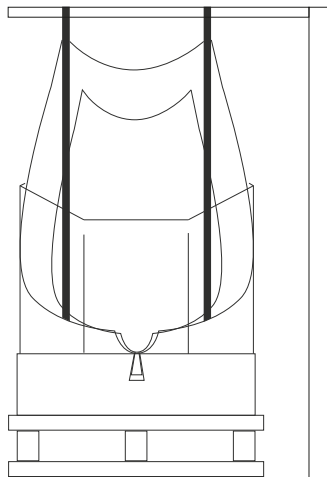

### BBL OCTABIN (CODE: 22)

MADE OF:

- PE liner
- PP big bag
- PP straps
- Corrugated cardboard
- Pallet CP9

ALTERNATIVE USE

- PE liner: garbage bag
- PP big bag: garbage bag
- corrugated cardboard: garbage bag
- wood: reusable

QUANTITY RANGE: 600-1000 kg

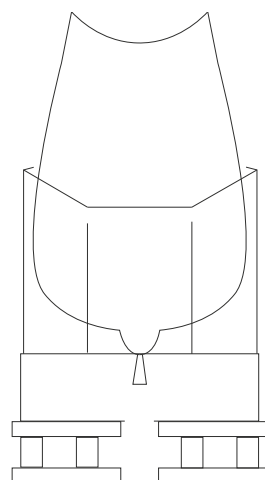

### BOTTOM DISCHARGE OCTABIN (CODE: 23)

MADE OF:

- PE liner
- PP straps
- Corrugated cardboard
- Pallet CP8

ALTERNATIVE USE

- PE liner: garbage bag
- corrugated cardboard: garbage bag
- wood: reusable

QUANTITY RANGE: 600-1000 kg

#### RECYCLING

dispose of in accordance with local requirements

